

1 or 2 Pole 16 A Step relays for direct 35 mm rail (EN 60715) mounting

- 17.4 mm wide
- Test button with mechanical indicators
- Choice of 7 switching sequences
- AC coils and DC coils
- Identification label
- Possible to connect illuminated push buttons with the additional part 026.00
- 35 mm rail (EN 60715) mount
- Cadmium free contact material

20.21/22/24/26/27/28/23

Screw terminal



FOR UL RATINGS SEE:

"General technical information" page V

For outline drawing see page 3

Contact specification

| Contact configuration | 1 NO (SPST-NO) | 2 NO (DPST-NO) | 1NO+1NC (SPST-NO+SPST-NC) |
|--|------------------------|--------------------|---------------------------|
| Rated current/Maximum peak current | A 16/30 | 16/30 | 16/30 |
| Rated voltage/ Maximum switching voltage | V AC 250/400 | 250/400 | 250/400 |
| Rated load AC1 | VA 4000 | 4000 | 4000 |
| Rated load AC15 (230 V AC) | VA 750 | 750 | 750 |
| Nominal lamp rating: | | | |
| 230 V incandescent/halogen W | 2000 | 2000 | 2000 |
| fluorescent tubes with electronic ballast W | 1000 | 1000 | 1000 |
| fluorescent tubes with electromechanical ballast W | 750 | 750 | 750 |
| CFL W | 400 | 400 | 400 |
| 230 V LED W | 400 | 400 | 400 |
| LV halogen or LED with electronic ballast W | 400 | 400 | 400 |
| LV halogen or LED with electromechanical ballast W | 800 | 800 | 800 |
| Minimum switching load | mW (V/mA) 1000 (10/10) | 1000 (10/10) | 1000 (10/10) |
| Standard contact material | AgSnO ₂ | AgSnO ₂ | AgSnO ₂ |

Coil specification

| | | | | |
|----------------------|-----------------|--|---------------------------|---------------------------|
| Nominal voltage (UN) | V AC (50/60 Hz) | 8 - 12 - 24 - 48 - 110 - 120 - 230 - 240 | | |
| | V DC | 12 - 24 - 48 - 110 | 12 - 24 - 48 - 110 | 12 - 24 - 48 - 110 |
| Rated power AC/DC | VA (50 Hz)/W | 6.5/5 | 6.5/5 | 6.5/5 |
| Operating range | AC | (0.85...1.1)U _N (50 Hz)/(0.9...1.1)U _N (60 Hz) | | |
| | DC | (0.9...1.1)U _N | (0.9...1.1)U _N | (0.9...1.1)U _N |

Technical data

| | | | | |
|--|--------|-----------------------------------|-----------------------------------|-----------------------------------|
| Mechanical life AC/DC | cycles | 300 · 10 ³ | 300 · 10 ³ | 300 · 10 ³ |
| Electrical life at rated load in AC1 | cycles | 100 · 10 ³ | 100 · 10 ³ | 100 · 10 ³ |
| Minimum/Maximum impulse duration | | 0.1 s/1 h (according to EN 60669) | 0.1 s/1 h (according to EN 60669) | 0.1 s/1 h (according to EN 60669) |
| Insulation between coil and contacts (1.2/50 μs) | kV | 4 | 4 | 4 |
| Ambient temperature range | °C | -40...+40 | -40...+40 | -40...+40 |
| Protection category | | IP 20 | IP 20 | IP 20 |

Approvals (according to type)



Ordering information

Example: 20 series relay, 35 mm rail (EN 60715) mount, double phase switch, 2 NO 16 A contacts, coil rated at 12 V DC, AgSnO₂ contacts.

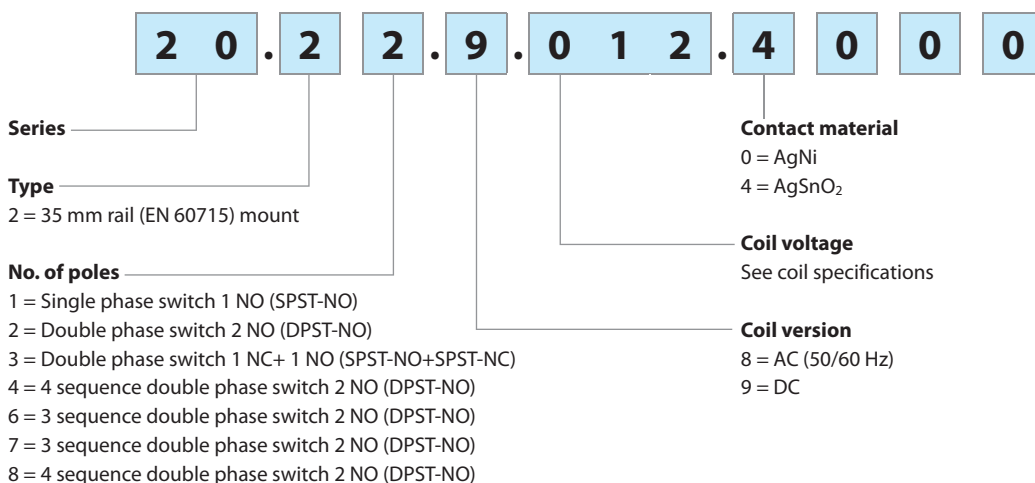

Technical data

Insulation

| | | |
|-----------------------------|------|------|
| Dielectric strength | | |
| between supply and contacts | V AC | 3500 |
| between open contacts | V AC | 2000 |
| between adjacent contacts | V AC | 2000 |

Other data

| | | | | | |
|---|-----------------|---------------------------|-------------------|----------------------------------|-----------------|
| Power lost to the environment | | | | | |
| with rated current and coil deenergised | W | 1.3 (20.21, 20.23, 20.28) | | 2.6 (20.22, 20.24, 20.26, 20.27) | |
|  Screw torque | Nm | 0.8 | | 0.8 | |
| Max. wire size | | Coil terminals | | Contact terminals | |
| | | solid cable | stranded cable | solid cable | stranded cable |
| | mm ² | 1 x 4 / 2 x 2.5 | 1 x 2.5 / 2 x 2.5 | 1 x 6 / 2 x 4 | 1 x 4 / 2 x 2.5 |
| | AWG | 1 x 12 / 2 x 14 | 1 x 14 / 2 x 14 | 1 x 10 / 2 x 12 | 1 x 12 / 2 x 14 |

If the coil is operated for a prolonged period of time, adequate ventilation of the relays must be provided - suggested gap of 9 mm between adjacent relays.





















Coil specifications

DC version data

| Nominal voltage U _N | Coil code | Operating range | | Resistance R | Consumption I at U _N |
|-----------------------------------|-----------|------------------|------------------|-----------------|------------------------------------|
| | | U _{min} | U _{max} | | |
| V | | V | V | Ω | mA |
| 12 | 9.012 | 10.8 | 13.2 | 27 | 440 |
| 24 | 9.024 | 21.6 | 26.4 | 105 | 230 |
| 48 | 9.048 | 43.2 | 52.8 | 440 | 110 |
| 110 | 9.110 | 99 | 121 | 2330 | 47 |

AC version data

| Nominal voltage U _N | Coil code | Operating range | | Resistance R | Consumption I at U _N (50 Hz) |
|-----------------------------------|-----------|------------------|------------------|-----------------|---|
| | | U _{min} | U _{max} | | |
| V | | V | V | Ω | mA |
| 8 | 8.008 | 6.8 | 8.8 | 4 | 800 |
| 12 | 8.012 | 10.2 | 13.2 | 7.5 | 550 |
| 24 | 8.024 | 20.4 | 26.4 | 27 | 275 |
| 48 | 8.048 | 40.8 | 52.8 | 106 | 150 |
| 110 | 8.110 | 93.5 | 121 | 590 | 64 |
| 120 | 8.120 | 102 | 132 | 680 | 54 |
| 230 | 8.230 | 192 | 253 | 2500 | 28 |
| 240 | 8.240 | 204 | 264 | 2700 | 27.5 |

| Type | Number of steps | Sequence | | | |
|-------|-----------------|---|---|---|---|
| | | 1 | 2 | 3 | 4 |
| 20.21 | 2 |  |  | | |
| 20.22 | 2 |  |  | | |
| 20.23 | 2 |  |  | | |
| 20.24 | 4 |  |  |  |  |
| 20.26 | 3 |  |  |  | |
| 20.27 | 3 |  |  |  | |
| 20.28 | 4 |  |  |  |  |

Wiring diagrams

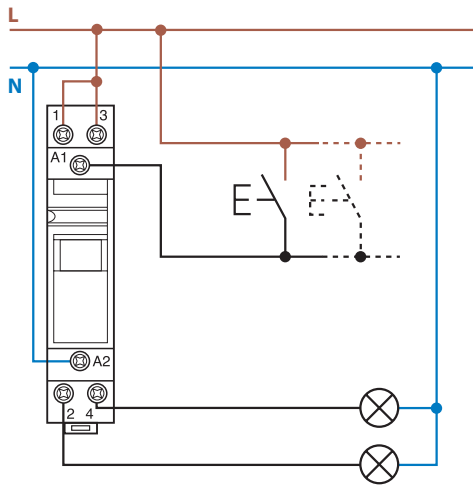

Example: 230 V AC supply voltage.

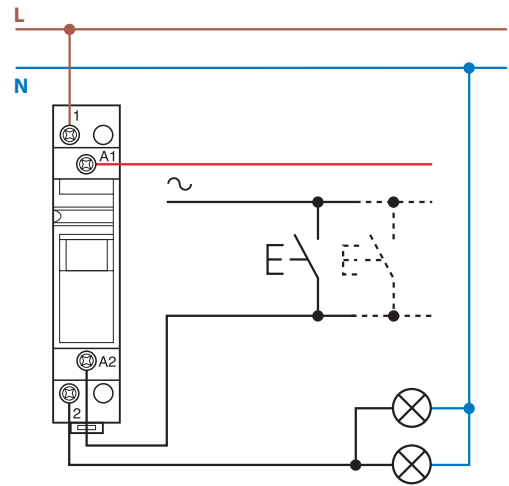

Example: 24 V AC supply voltage.

Outline drawings

20.21
Screw terminal

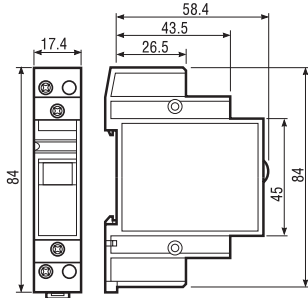

20.22/24/26/27/28
Screw terminal

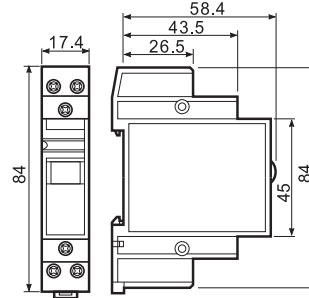

20.23
Screw terminal

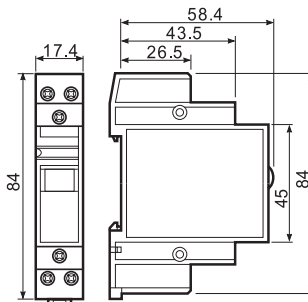

Accessories

Module for use with illuminated push-buttons

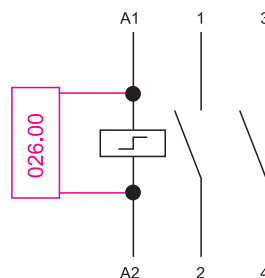
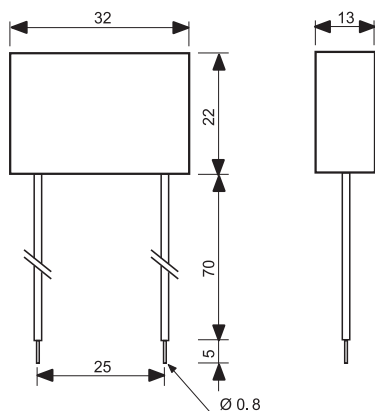

Type 026.00

Sealed construction, 7.5 cm insulated flexible wire termination.

Example of wiring diagram of type 026.00

This module is necessary when using between 1 and a maximum of 15 illuminated push buttons in the coil circuit (Each 1.5 mA max, 230 V AC). It must be connected in parallel to the coil of the relay.



020.01

Adaptor for panel mounting, 17.5 mm wide

020.01

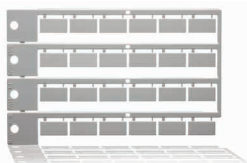

020.24

Sheet of marker tags, plastic, 24 tags, 9 x 17 mm

020.24



022.09

Separator for rail mounting, plastic, 9 mm wide

022.09

