

1 & 2 CO relay interface modules, 15.8 mm wide with Push-in terminal
Ideal interface for PLC and electronic systems

Type 4C.P1

- 1 CO 10 A

Type 4C.P2

- 2 CO 8 A

- AC coils or DC coils
- Supply status indication and coil suppression module as standard
- Identification label
- UL Listing (certain relay/socket combinations)
- 35 mm rail (EN 60715) mounting

4C.P1 / 4C.P2
Push-in terminals



- 1 CO 10 A
- Push-in terminals

- 2 CO 8 A
- Push-in terminals

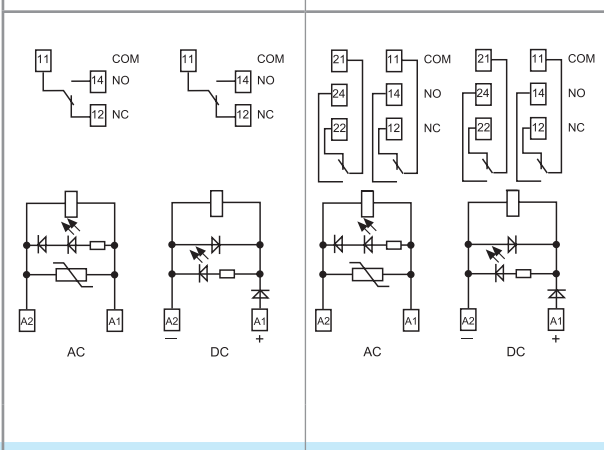

For outline drawing see page 5

Contact specification

Contact configuration		1 CO (SPDT)	2 CO (DPDT)
Rated current/Maximum peak current	A	10/25	8/15
Rated voltage/Maximum switching voltage	V AC	250/440	250/440
Rated load AC1	VA	4000	2000
Rated load AC15 (230 V AC)	VA	750	350
Single phase motor rating (230 V AC)	kW	0.55	0.37
Breaking capacity DC1: 30/110/220 V	A	10/0.5/0.15	6/0.5/0.15
Minimum switching load	mW (V/mA)	300 (5/5)	300 (5/5)
Standard contact material		AgNi	AgNi

Coil specification

Nominal voltage (U_N)	V AC (50/60 Hz)	12 - 24 - 110 - 120 - 230	12 - 24 - 110 - 120 - 230
	V DC	12 - 24 - 125	12 - 24 - 125
Rated power AC/DC	VA (50 Hz)/W	1.2/0.5	1.2/0.5
Operating range	AC	$(0.8 \dots 1.1)U_N$	$(0.8 \dots 1.1)U_N$
	DC	$(0.73 \dots 1.1)U_N$	$(0.73 \dots 1.1)U_N$
Holding voltage	AC/DC	$0.8 U_N / 0.4 U_N$	$0.8 U_N / 0.4 U_N$
Must drop-out voltage	AC/DC	$0.2 U_N / 0.1 U_N$	$0.2 U_N / 0.1 U_N$

Technical data

Mechanical life AC/DC	cycles	$10 \cdot 10^6$	$10 \cdot 10^6$
Electrical life at rated load AC1	cycles	$100 \cdot 10^3$	$100 \cdot 10^3$
Operate/release time	ms	15/5 (AC) - 15/12 (DC)	10/3 (AC) - 10/10 (DC)
Insulation between coil and contacts (1.2/50 μ s)	kV	6 (8 mm)	6 (8 mm)
Dielectric strength between open contacts	V AC	1000	1000
Ambient temperature range	$^{\circ}$ C	-40...+70	-40...+70
Protection category		IP 20	IP 20

Approvals - relay (according to type)



**1 & 2 CO relay interface modules,
15.8 mm wide with screw terminal**
Ideal interface for PLC and electronic systems

Type 4C.01

- 1 CO 16 A

Type 4C.02

- 2 CO 8 A

- AC coils or DC coils
- Supply status indication and coil suppression module as standard
- Identification label
- UL Listing (certain relay/socket combinations)
- 35 mm rail (EN 60715) mounting

4C.01 / 4C.02

Screw terminals



For outline drawing see page 5

Contact specification

Contact configuration		1 CO (SPDT)	2 CO (DPDT)
Rated current/Maximum peak current	A	16/25	8/15
Rated voltage/ Maximum switching voltage	V AC	250/440	250/440
Rated load AC1	VA	4000	2000
Rated load AC15 (230 V AC)	VA	750	350
Single phase motor rating (230 V AC)	kW	0.55	0.37
Breaking capacity DC1: 30/110/220 V	A	16/0.5/0.15	6/0.5/0.15
Minimum switching load	mW (V/mA)	300 (5/5)	300 (5/5)
Standard contact material		AgNi	AgNi

Coil specification

Nominal voltage (U _N)	V AC (50/60 Hz)	12 - 24 - 110 - 120 - 230	12 - 24 - 110 - 120 - 230
	V DC	12 - 24 - 125	12 - 24 - 125
Rated power AC/DC	VA (50 Hz)/W	1.2/0.5	1.2/0.5
Operating range	AC	(0.8...1.1)U _N	(0.8...1.1)U _N
	DC	(0.73...1.1)U _N	(0.73...1.1)U _N
Holding voltage	AC/DC	0.8 U _N / 0.4 U _N	0.8 U _N / 0.4 U _N
Must drop-out voltage	AC/DC	0.2 U _N / 0.1 U _N	0.2 U _N / 0.1 U _N

Technical data

Mechanical life AC/DC	cycles	10 · 10 ⁶	10 · 10 ⁶
Electrical life at rated load AC1	cycles	100 · 10 ³	100 · 10 ³
Operate/release time	ms	15/5 (AC) - 15/12 (DC)	10/3 (AC) - 10/10 (DC)
Insulation between coil and contacts (1.2/50 μs)	kV	6 (8 mm)	6 (8 mm)
Dielectric strength between open contacts	V AC	1000	1000
Ambient temperature range	°C	≤ 12 A: -40...+70 / > 12 A: -40...+50	-40...+70
Protection category		IP 20	IP 20

Approvals - relay (according to type)



4C.01



- 1 CO 16 A
- Screw terminals

4C.02



- 2 CO 8 A
- Screw terminals

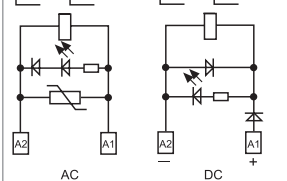
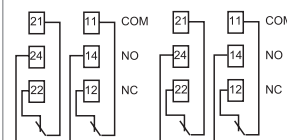
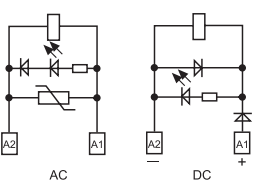
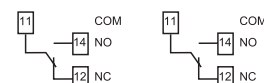

Ordering information

Example: 4C series, 35 mm rail (EN 60715) mount, Push-in terminal relay interface module, 1 CO 10 A contacts, 24 V DC coil, green LED + diode.

	4 C . P	1 . 9 . 0 2 4 . 0	A	B	C	D
Series			A: Contact material			D: Special versions
Type	0 = 35 mm rail (EN 60715) mount screw terminal socket P = 35 mm rail (EN 60715) mount Push-in terminal socket		0 = AgNi 4 = AgSnO ₂ 5 = AgNi + Au			0 = Standard
No. of poles	1 = 1 pole 2 = 2 pole		B: Contact circuit		C: Options	5 = Standard for DC: green LED + diode (polarity +A1) 6 = Standard for AC: green LED + Varistor
Coil version	8 = AC (50/60 Hz) 9 = DC		0 = CO (nPDT)			
Coil voltage	See coil specifications					

Selecting features and options: only combinations in the same row are possible.
Preferred selections for best availability are shown in **bold**.

Type	Coil version	A	B	C	D
4C.02	AC	0 - 5	0	6	0
4C.P2	DC	0 - 5	0	5	0
4C.01	AC	0 - 4 - 5	0	6	0
4C.P1	DC	0 - 4 - 5	0	5	0

Technical data

Insulation				
Insulation according to EN 61810-1	insulation rated voltage	V	250	440
	rated impulse withstand voltage	kV	4	4
	pollution degree		3	2
	overvoltage category		III	III
Insulation between coil and contacts (1.2/50 µs)		kV	6 (8 mm)	
Dielectric strength between open contacts		V AC	1000	
Dielectric strength between adjacent contacts		V AC	2000	
Conducted disturbance immunity				
Burst (5...50)ns, 5 kHz, on A1 - A2			EN 61000-4-4	level 4 (4 kV)
Surge (1.2/50 µs) on A1 - A2 (differential mode)			EN 61000-4-5	level 3 (2 kV)
Other data				
Bounce time: NO/NC		ms	2/6 (4C.01/P1)	1/4 (4C.02/P2)
Vibration resistance (10...150)Hz: NO/NC		g	20/12	
Power lost to the environment	without contact current	W	0.6	
	with rated current	W	1.6 (4C.01/P1)	2 (4C.02/P2)
Terminals				
Wire strip length		mm	4C.01/4C.02	4C.P1/4C.P2
Screw torque		Nm	0.8	
Max. wire size			solid cable	stranded cable
		mm ²	1 x 6 / 2 x 2.5	1 x 4 / 2 x 2.5
			2 x (0.5...1.5)	2 x (0.5...1.5)
		AWG	1 x 10 / 2 x 14	1 x 12 / 2 x 14
			2 x (21...18)	2 x (21...18)



Contact specification

F 4C - Electrical life (AC) v contact current

Types 4C.02/P2

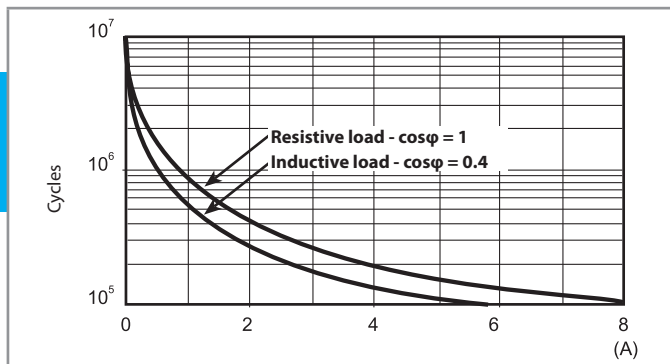

F 4C - Electrical life (AC) v contact current

Types 4C.01/P1

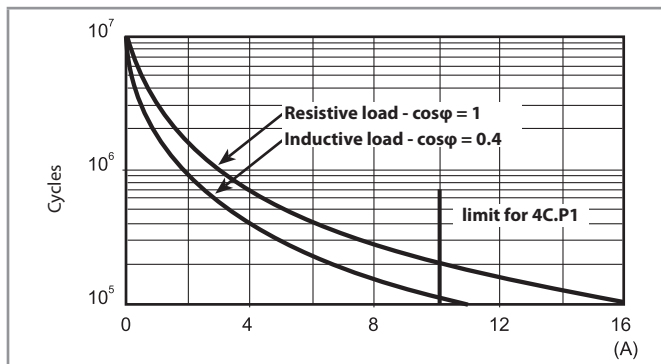

H 4C - Maximum DC1 breaking capacity

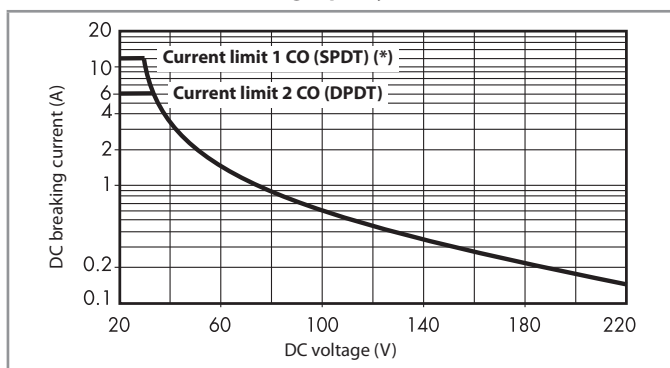

(*) Type 4C.01 = 12 A, Type 4C.P1 = 10 A

- When switching a resistive load (DC1) having voltage and current values under the curve, an electrical life of $\geq 100 \cdot 10^3$ can be expected.
- In the case of DC13 loads, the connection of a diode in parallel with the load will permit a similar electrical life as for a DC1 load. Note: the release time for the load will be increased.

Coil specifications

DC coil data

Nominal voltage U_N	Coil code	Operating range		Resistance R	Rated coil consumption I at U_N
		U_{min}	U_{max}		
V		V	V	Ω	mA
12	9.012	8.8	13.2	300	40
24	9.024	17.5	26.4	1200	20
125	9.125	91.2	138	32000	3.9

AC coil data

Nominal voltage U_N	Coil code	Operating range		Resistance R	Rated coil consumption I at U_N
		U_{min}	U_{max}		
V		V	V	Ω	mA
12	8.012	9.6	13.2	80	90
24	8.024	19.2	26.4	320	45
110	8.110	88	121	6900	9.4
120	8.120	96	132	9000	8.4
230	8.230	184	253	28000	5

R 4C - DC coil operating range v ambient temperature

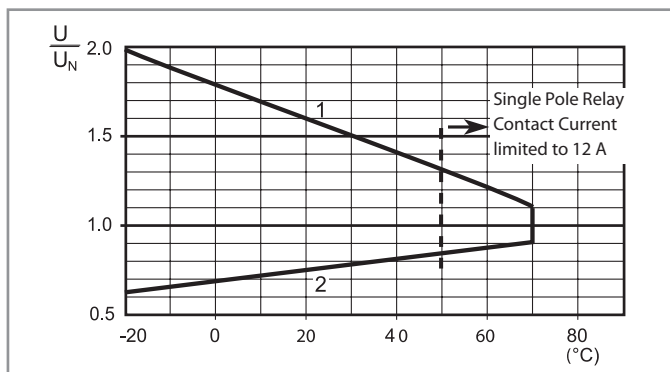

- 1 - Max. permitted coil voltage.
- 2 - Min. pick-up voltage with coil at ambient temperature.

R 4C - AC coil operating range v ambient temperature

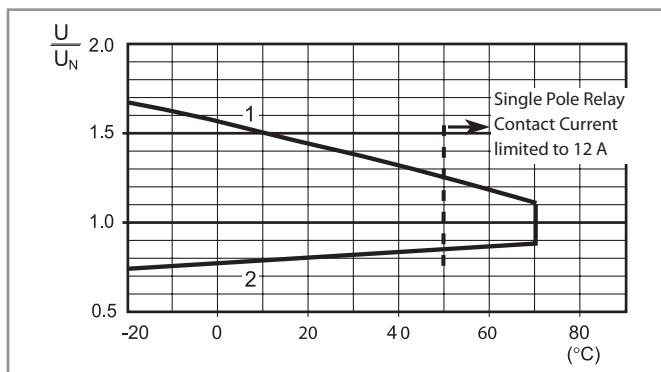

- 1 - Max. permitted coil voltage.
- 2 - Min. pick-up voltage with coil at ambient temperature.

----- Temperature limit for the single pole version under full 16 A contact current.

Combinations

Code	Type of socket	Type of relay	Module	Retaining clip
4C.P1	97.P1	46.61	99.02	097.01
4C.P2	97.P2	46.52	99.02	097.01
4C.01	97.01	46.61	99.02	097.01
4C.02	97.02	46.52	99.02	097.01

Certain relay/socket combinations

Outline drawing

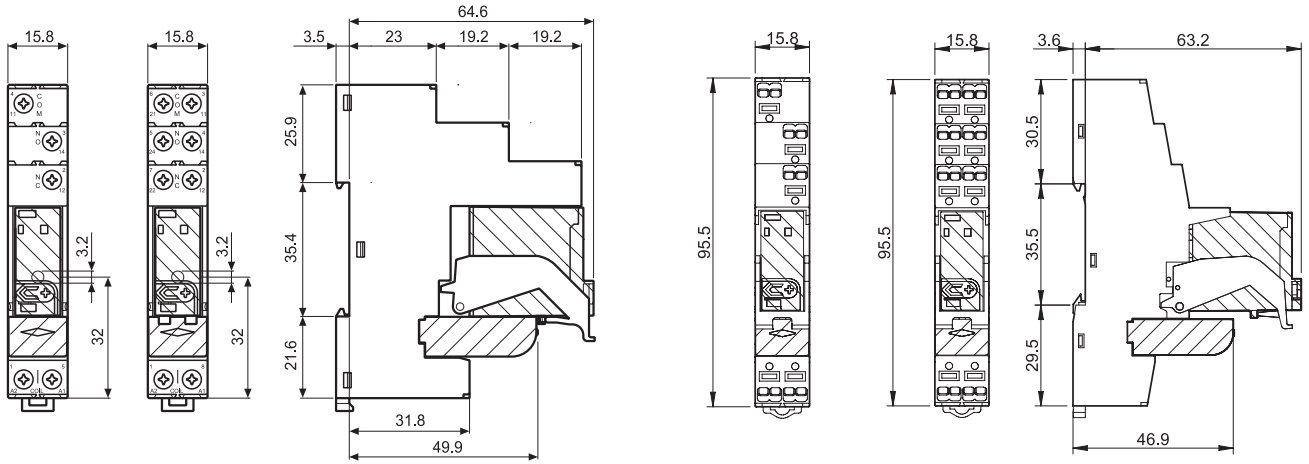

4C.01 / 4C.02
Screw terminals



4C.P1 / 4C.P2
Push-in terminals



Accessories



097.58

8-way jumper link for type 4C.P1 and 4C.P2	097.58
Rated values	10 A - 250 V

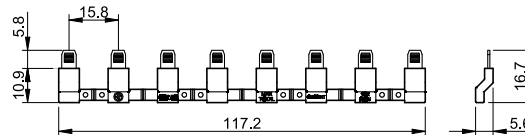

097.52

2-way jumper link for type 4C.P1 and 4C.P2	097.52
Rated values	10 A - 250 V

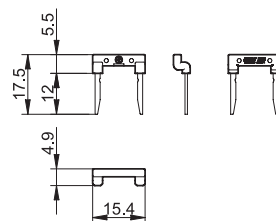

097.42

2-way jumper link for type 4C.P1 and 4C.P2	097.42
Rated values	10 A - 250 V

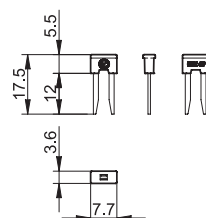

Accessories



097.00

Marker tag holder for type 4C.P1/P2/01/02

097.00

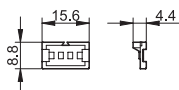

8-way jumper link for 4C.01 and 4C.02

095.18 (blue)

Rated values

10 A - 250 V

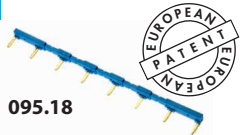
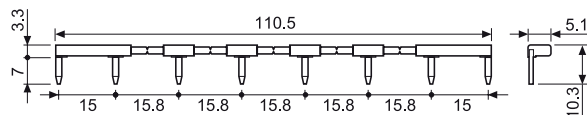

095.18

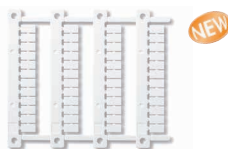

060.48

Sheet of marker tags (CEMBRE'S Thermal transfer printers), marker tag holder 097.00 or on the relay 46 series, plastic, 48 tags, 6 x 12 mm

060.48

Packaging codes

How to code and identify retaining clip and packaging options for relay interface module.

Example:

4 C . P 1 . 9 . 0 2 4 . 0 0 5 0 S P A

A Standard packaging
B Blister packaging

SP Plastic retaining clip